

74

1-73

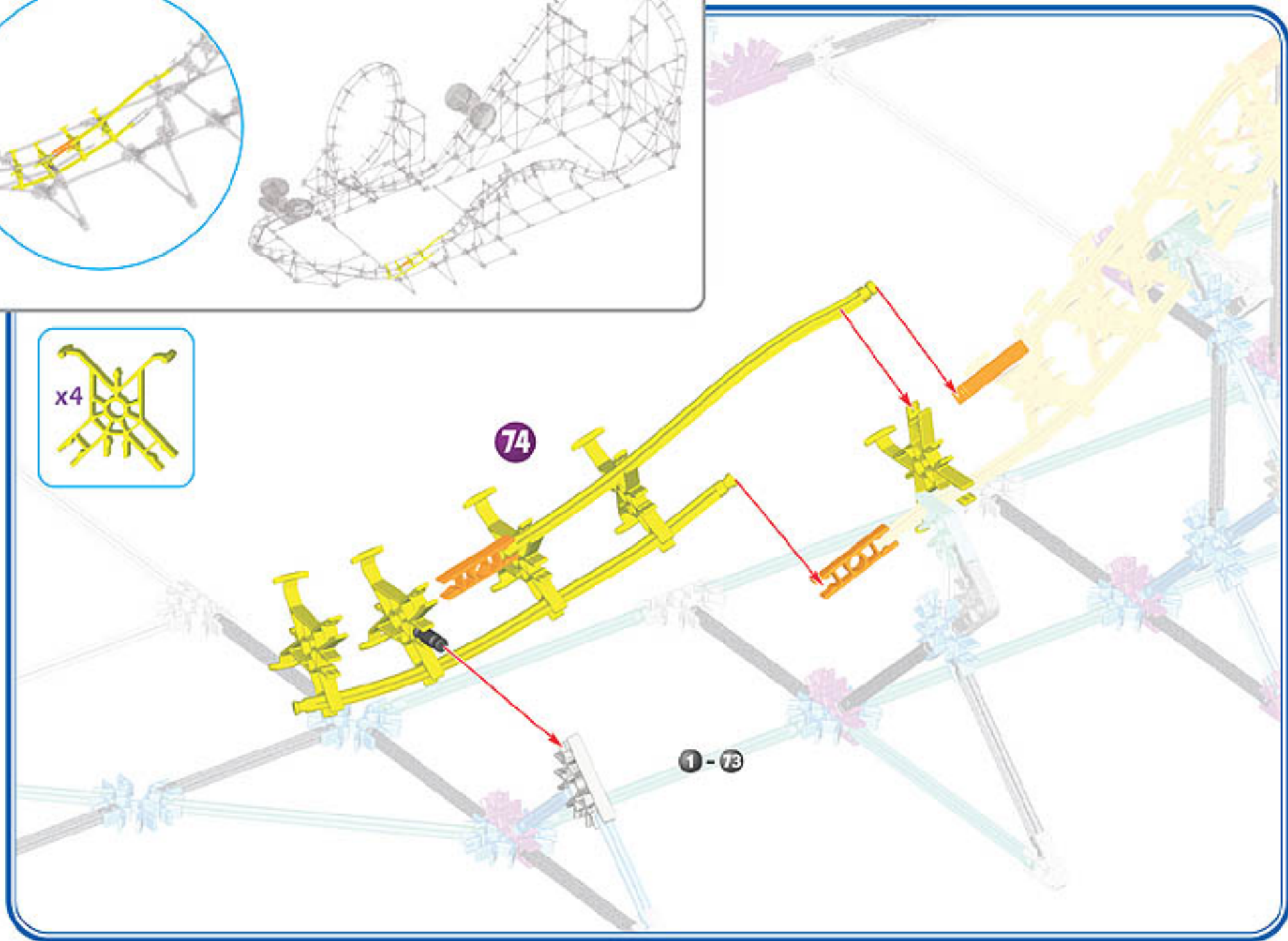

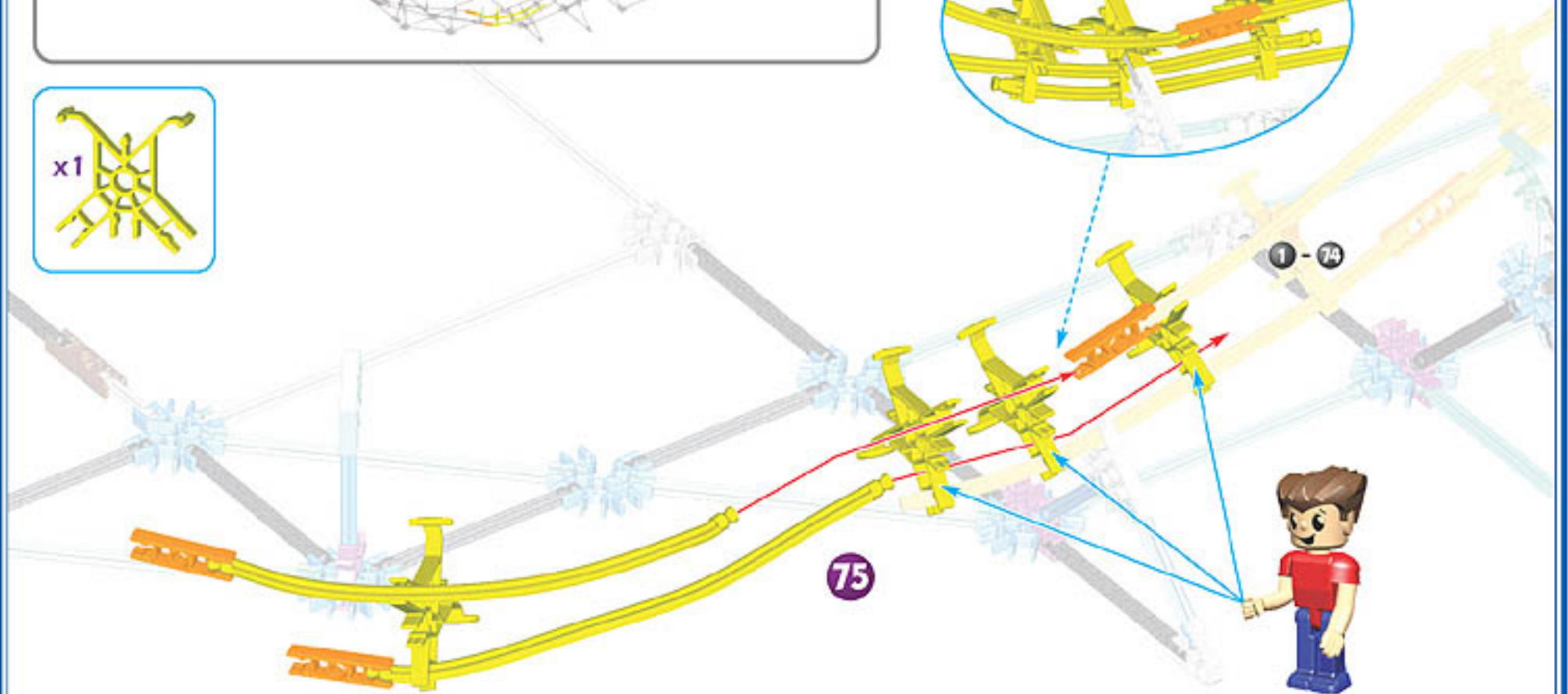
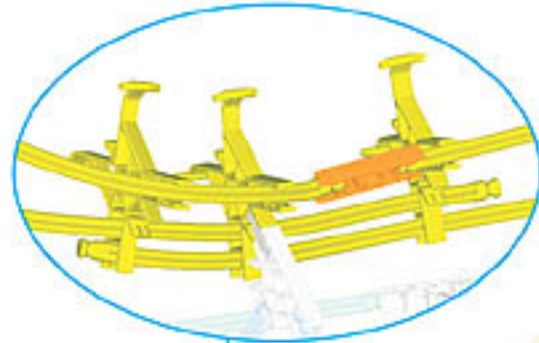
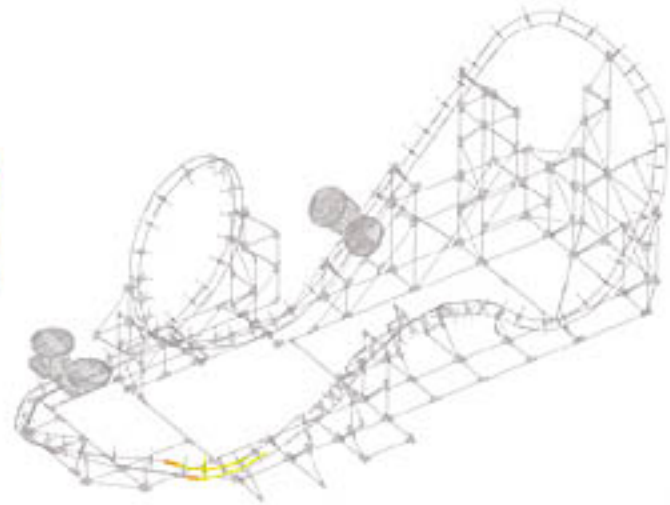
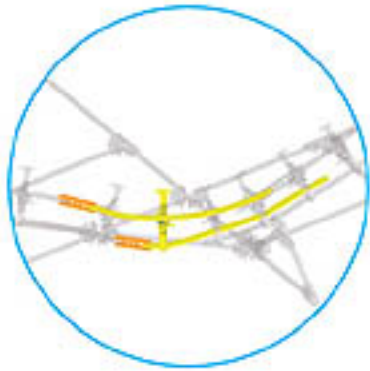

Rod goes through the square hole in these Track Connectors.



Now it's time to put on both sides of the Track!

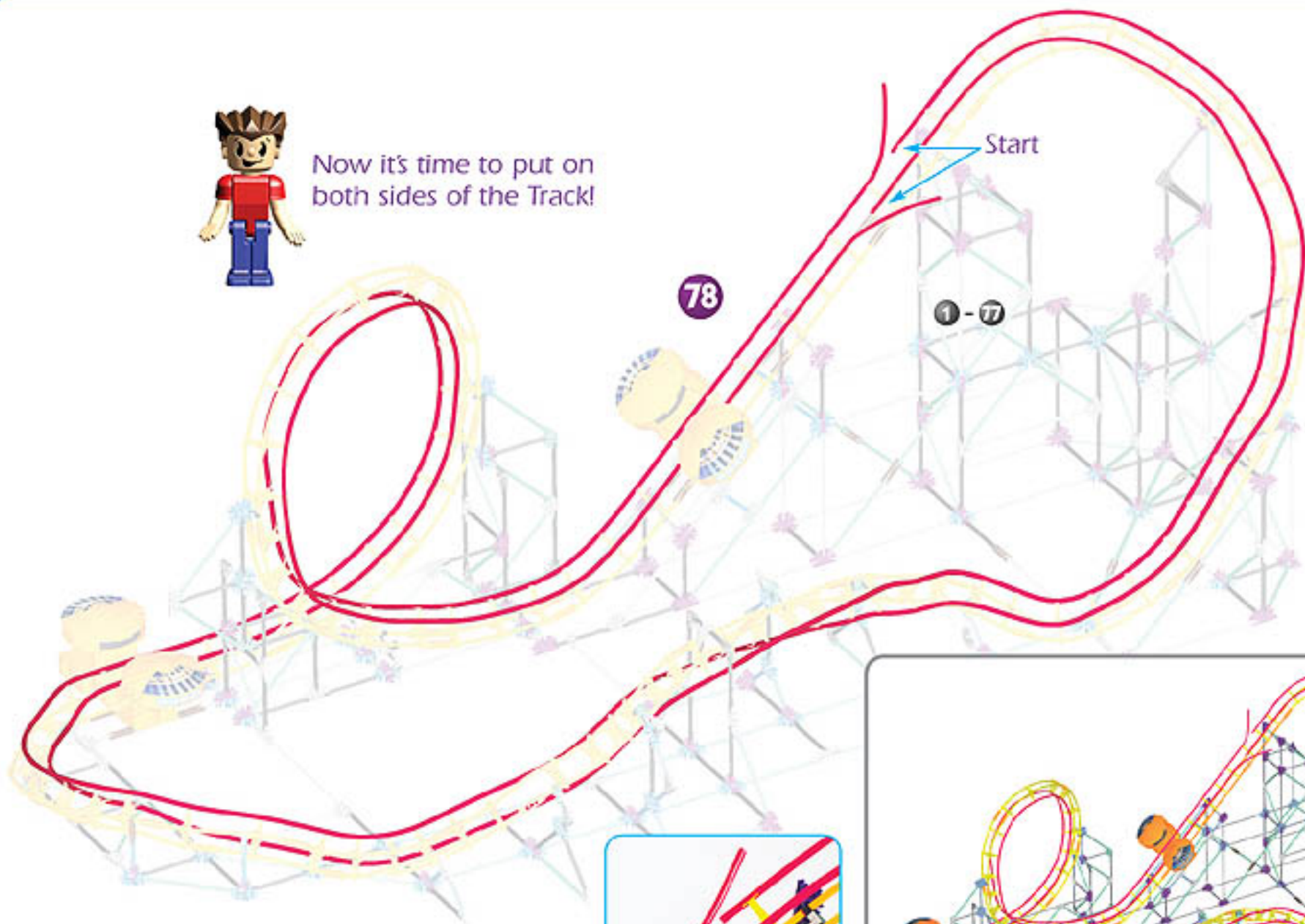

Don't cut Track yet.

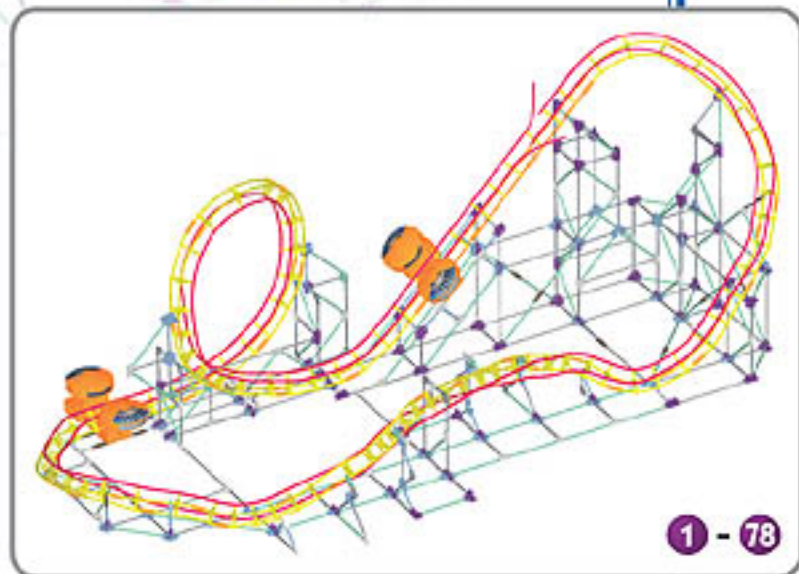

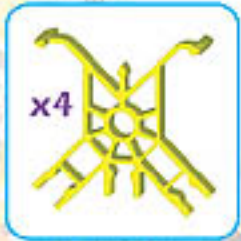
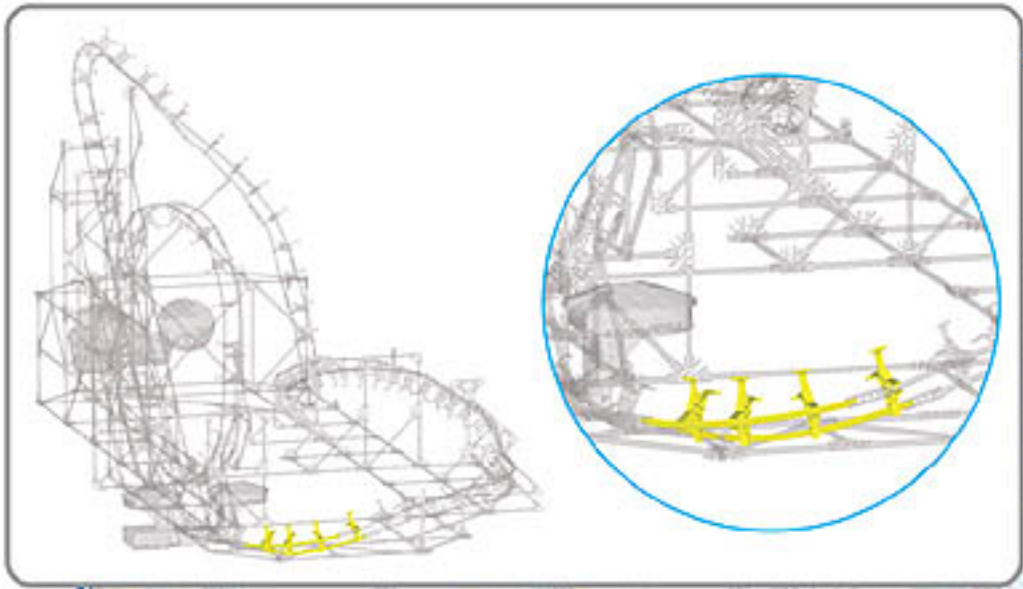

77

1-76

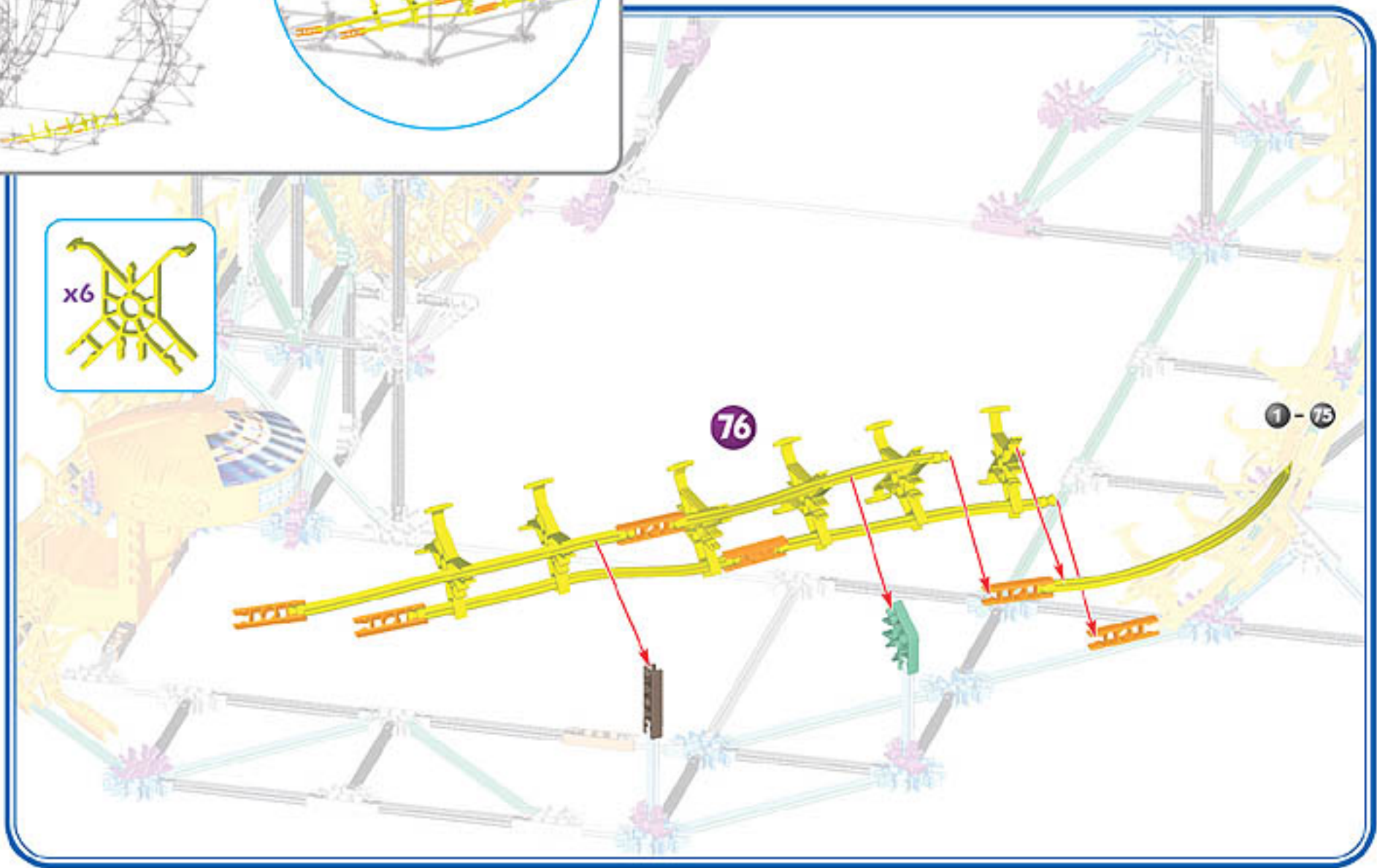
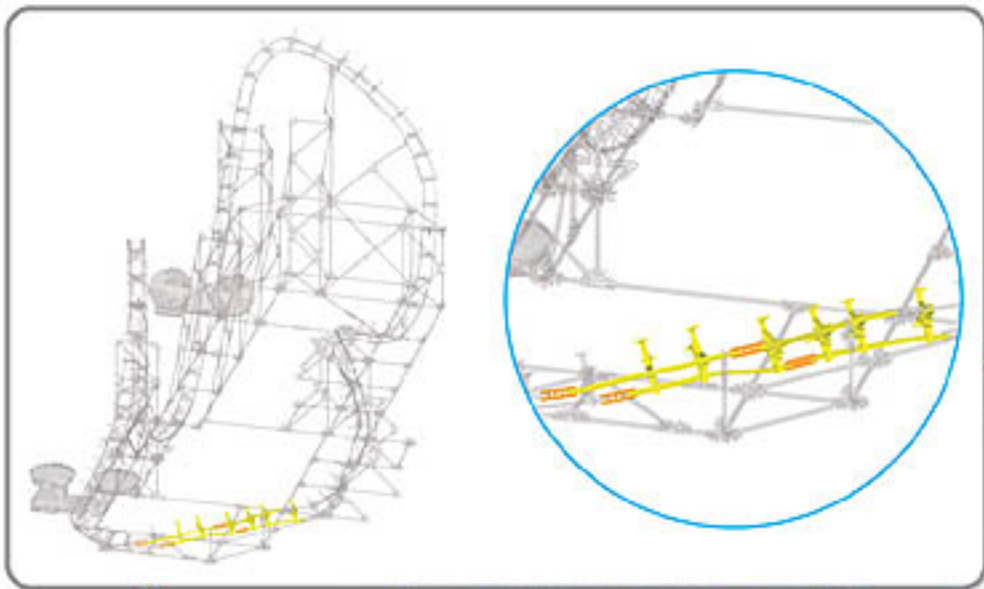

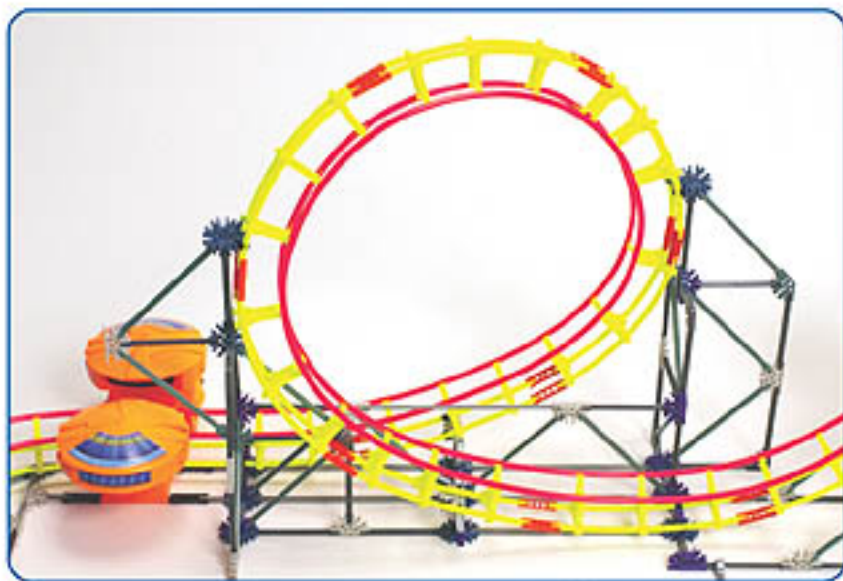

It's important to smooth out the Track, especially in the loop area, before you finally cut the Track.

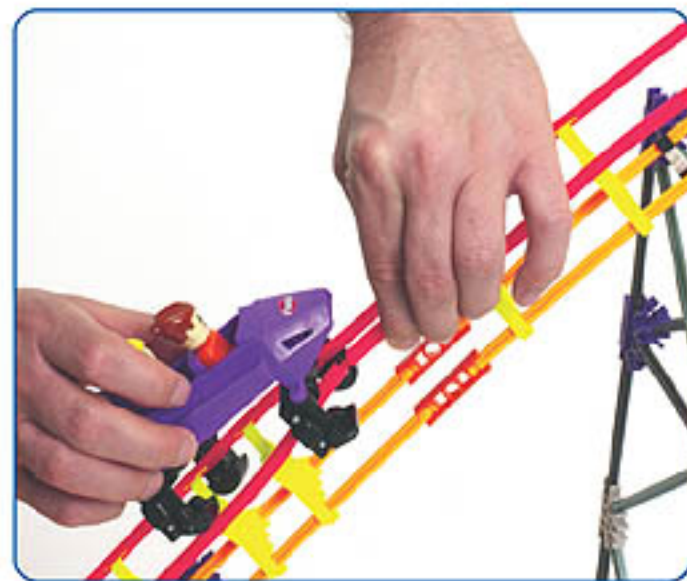

To attach rocket car, squeeze the Track together and put one side of the car on first, then the other side.



Use sharp scissors to cut the Track as shown.
(Adult help is recommended)

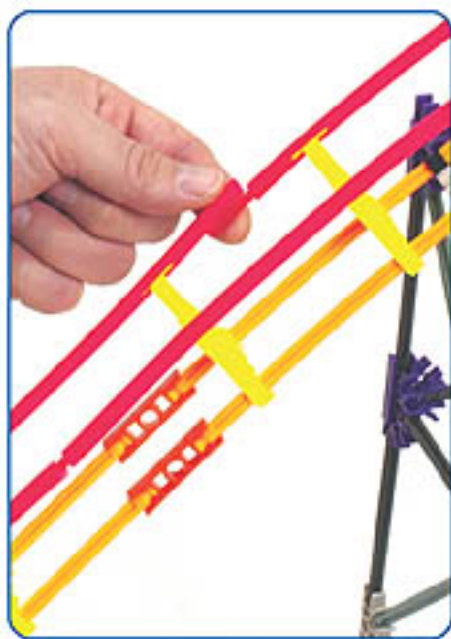

Use a splicer to connect the ends of the track.

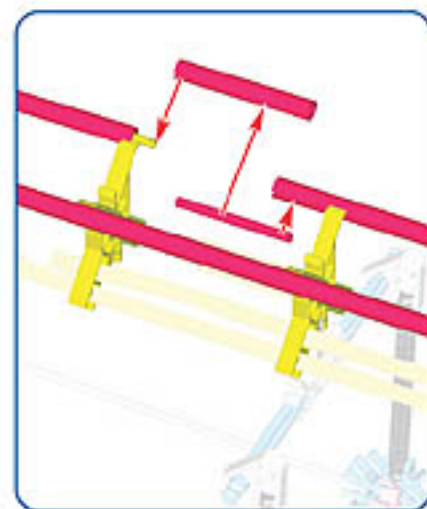

If you cut the Track too short, cut a little more off and then cut a filler piece of Track and splice them together.